

Programme Outcome of different Departments:

Department of Assamese

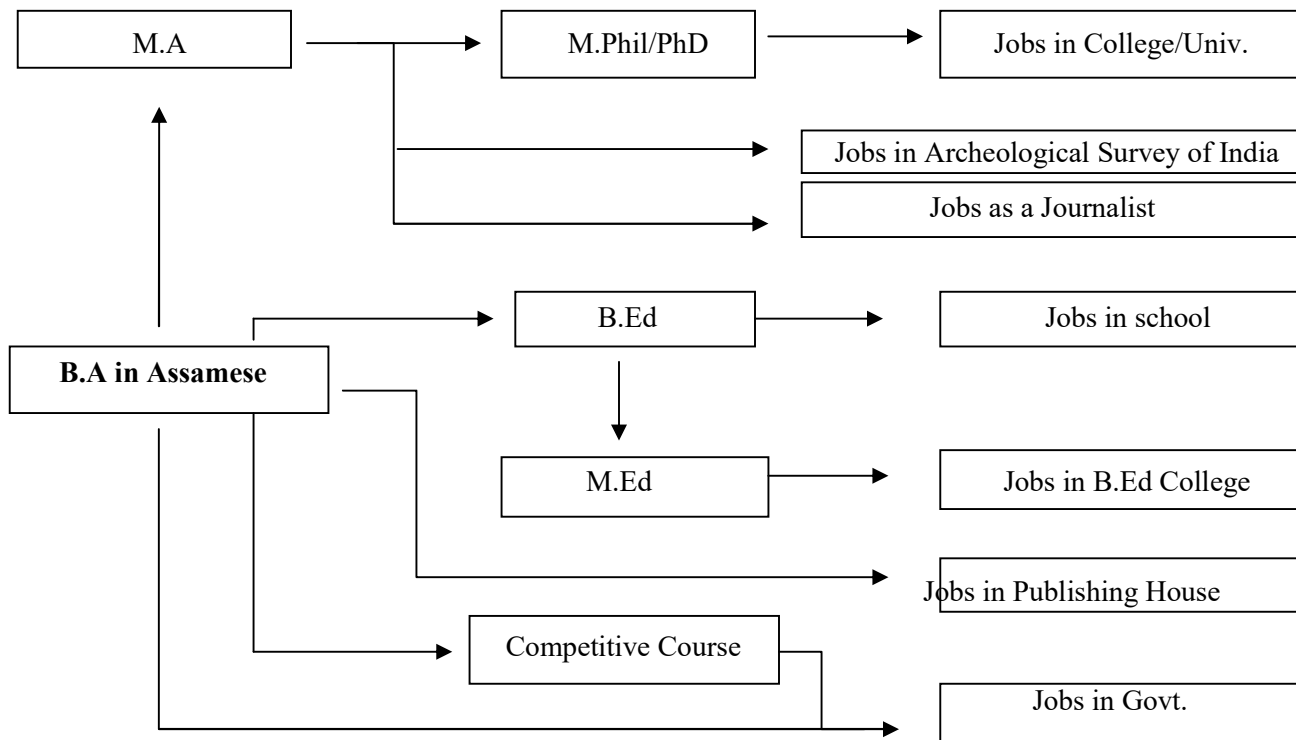

Assamese is a Major regional language of Assam. Students after graduating in Assamese can pursue M.A. in the subject & by pursuing M.Phil/PhD there is scope of jobs in college & Universities. After BA another option is the B.Ed, Library Science & after this by completing PG, they can get chance of employment as teaching faculty in the B.Ed & other colleges. Without entering into the University they can appear in the competitive examinations to be qualified for administrative jobs. There is also scope of jobs in publishing houses, translator or any other Govt/PSU.

Programme Outcome:

Department of Bengali

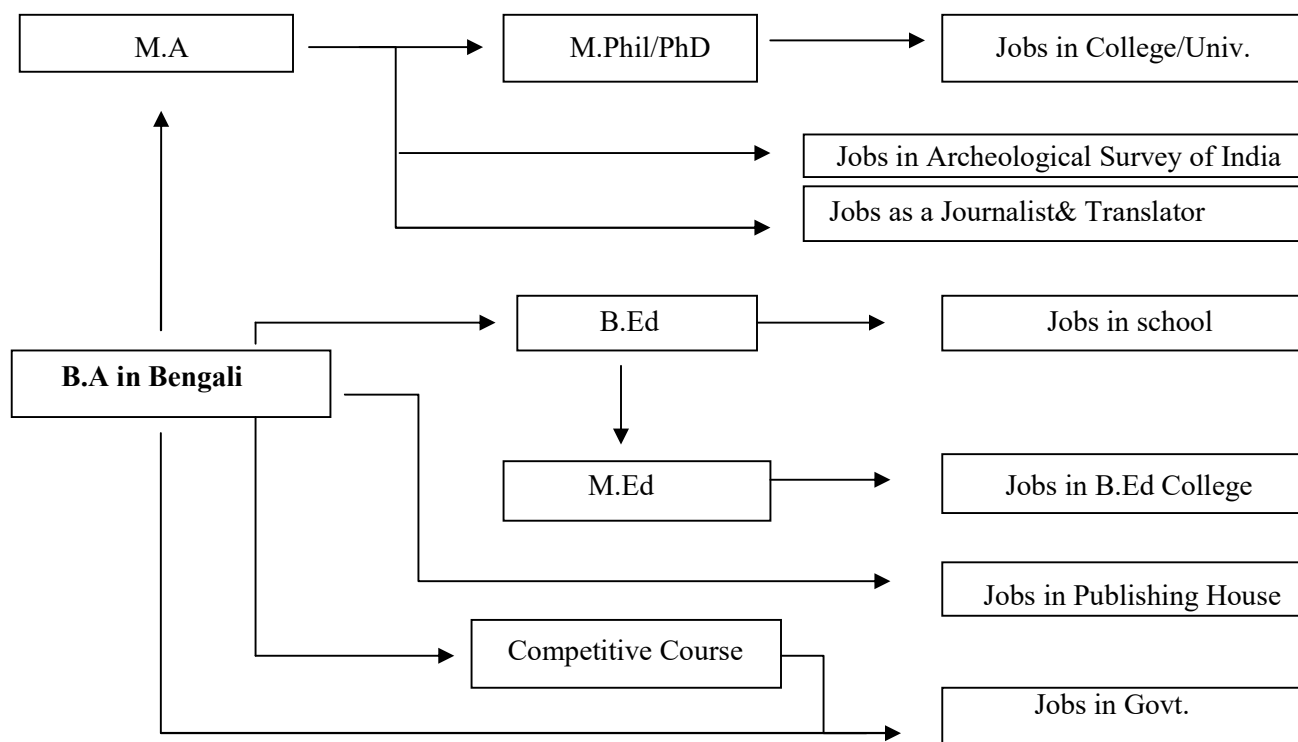

Bengali is one of the important Major Indian Languages of Assam. Students after graduating in Bengali can pursue M.A. in the subject & by pursuing M.Phil/PhD there is scope of jobs in college & Universities. After BA another option is the B.Ed, Library Science & after this by completing PG They can get the chance of employment as teaching faculty in the BEd & other colleges. Without entering into the University they can appear in the competitive examination to be qualified for administrative jobs. There is also scope of jobs in publishing houses, Translator or any other govt/PSU.

Programme Outcome:

Department of Bodo

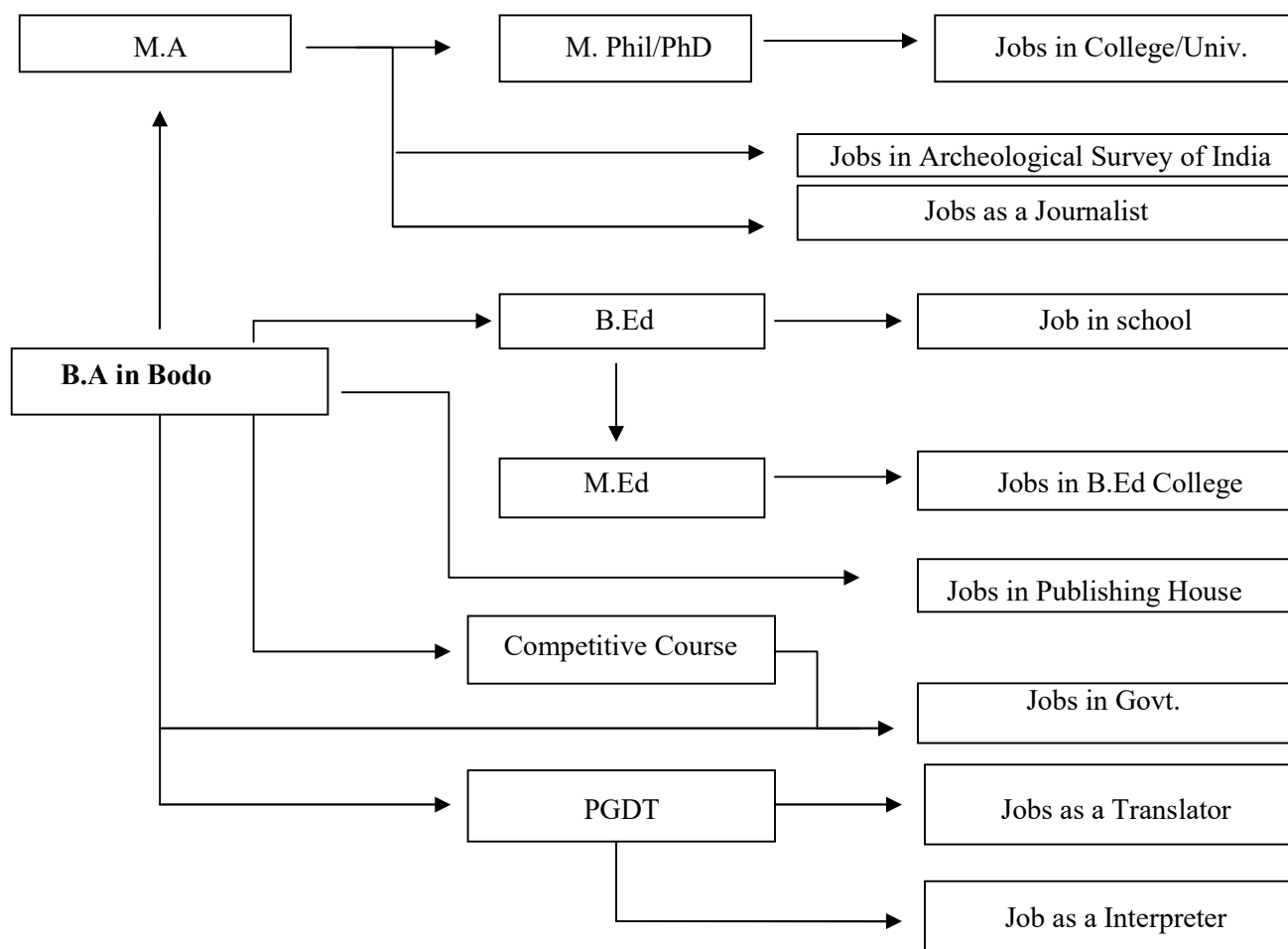

The students after graduating in Bodo (Regional Language) can directly enter into University for master degree and after this by pursuing PhD/M.Phil be unable to get jobs in college/university after obtaining Master degree there is scope of jobs in Archeological survey & Journalist. Without entering into University just after graduation they can pursue competitive course or PGDT to become eligible for jobs as translator or interpreter. There is also scope for jobs in publishing houses & food processing. One can pursue Bed course to be get jobs in school or can pursue MED to become eligible for the post of prof. in B.Ed. college.

Programme Outcome:

Department of Economics

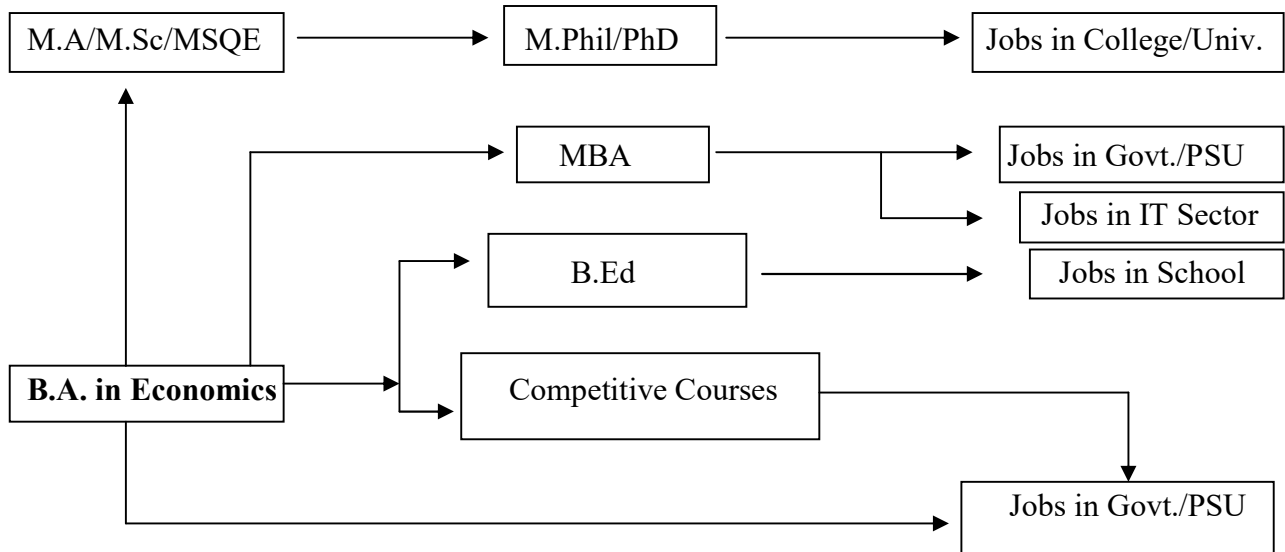

Master of Science in Quantitative Economics (MSQE)

After completing BA with economics as Major Subject a student can directly enter the University for Master Degree which will lead then to further opt. for Pd.D./M.Phil for seeking jobs in colleges/university. Options are also left to pursue M.Com, M.Sc in economics along with various options like M.B.A./P.G.D.M, B.Ed, M.Ed, LLB, LLM, MSW etc. After graduation they will able to find jobs in various government and non-government organizations like Banking and Finance, Insurance Sector, Stock Market, Journalism, actuarial Science, Reserve Bank of India, Ministry of Economic affairs, Planning Commission of India, National sample survey and Indian Economic Service.

Besides making their eligible for Masters Program, they can get jobs as a Researches, Teachers, Prof, Sales Analyst, Budget Analyst, Financial Advisor, Investment Analyst, Economist, Customer Profit Analyst, Investment Administrator writer and journalist.

Programme Outcome:

Department of Education

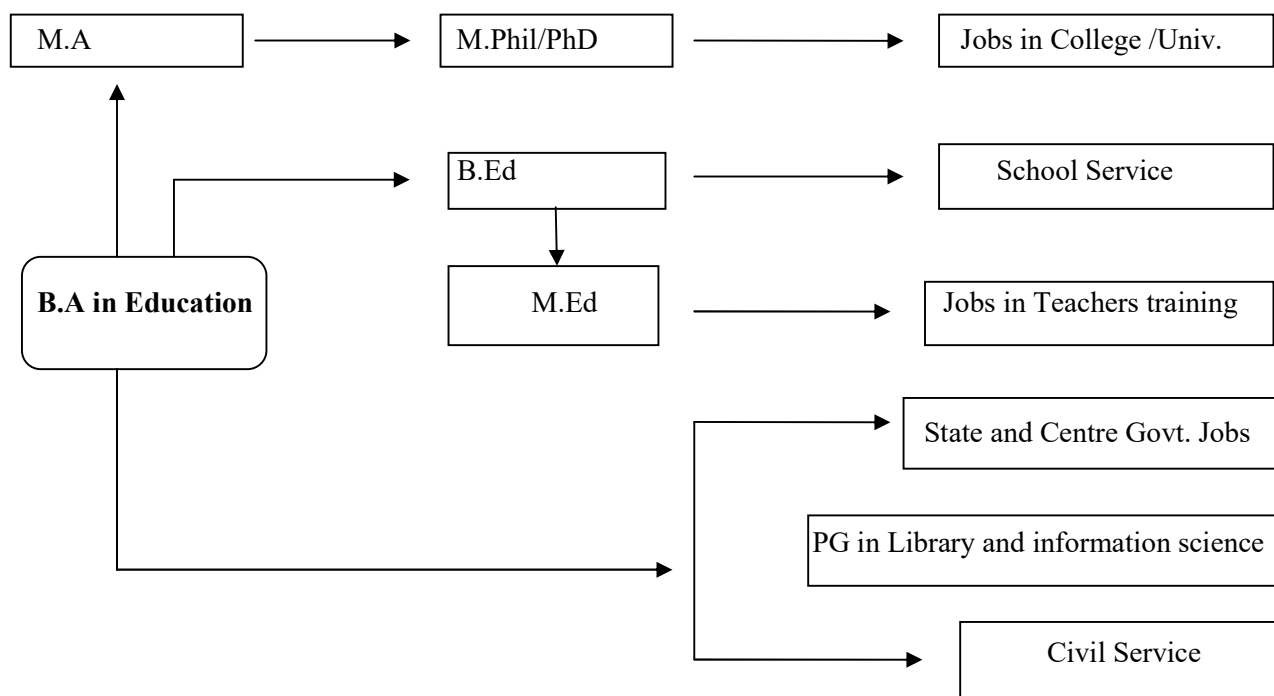

Education is one of the important subjects of Arts stream. Being graduate in Education students can directly complete PG course in the subject & by pursuing M.Phil/PhD they can be qualified for teaching faculty in college & Universities. There is scope of pursuing B.Ed. for the graduates in Education to be qualified for teaching in schools and after completing M.Ed., jobs in Teacher Training colleges or Diet are open to them. Graduates in Education can enter into any state or central govt. jobs. They can also appear in civil service examination to be employed in administrative jobs. PG in library & information science is also another option after graduation to be qualified for jobs as librarian.

Programme Outcome:

Department of English

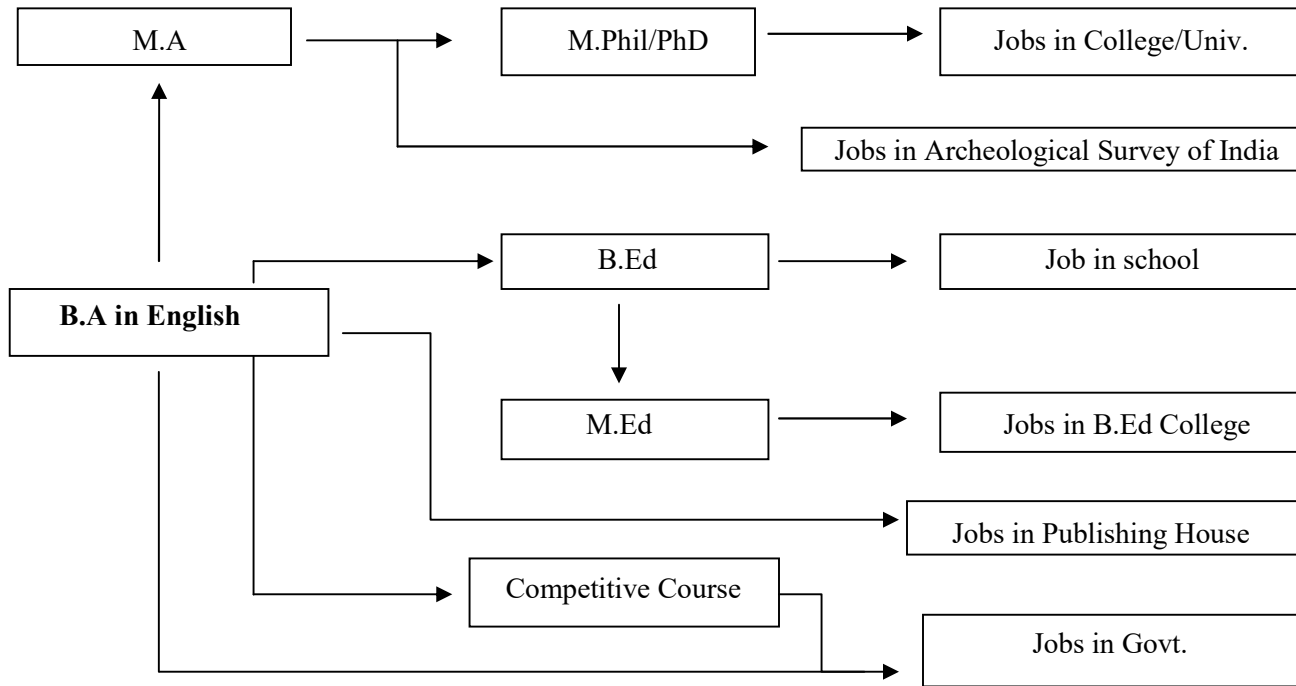

Course Outcome:

The Department of English, Tangla College seeks to promote the overall intellectual development of the students by encouraging study of literature and language. The Department strives to make its Honors and Regular program students familiar with the wide range of works of British literature in particular and world literature in general with special focus on North East literature and Indian writing in English. The issues of culture, history, gender, race, class, ethnicity, politics etc. are addressed and negotiated in the process of imparting knowledge of English in its pluralistic forms, to help the students develop a critical mindset of their own.

The Department hopes that each student who graduates with a BA (Hons.) program in English from Tangla College, will have an enduring interest in literature and language. They will also be able to understand the complex realities of human existence and gain insight knowledge of human behavior and values. With the introduction of CBCS course, the students can now choose the subject of study on their own, thus, providing them with more flexibility and applicability. The inter-disciplinary course offers them more scope to study diverse course across disciplines. After graduation, they will be able to find jobs in various government and non-government organizations,

besides, making them eligible for Masters Program, Civil service examinations and other competitive examinations. They will also be eligible for B.Ed courses and will be able to find jobs in publishing houses and can be authors, poets, novelist, content writers, bloggers etc. Post graduation, they will be able to find themselves in various BPO jobs, Newspaper and Broadcasting firms, Mass Communication, Translator, Interpreter etc. They will also be able to work as an English Language Consultant, Communication Skills Trainer etc.

Programme Outcome:

Department of History

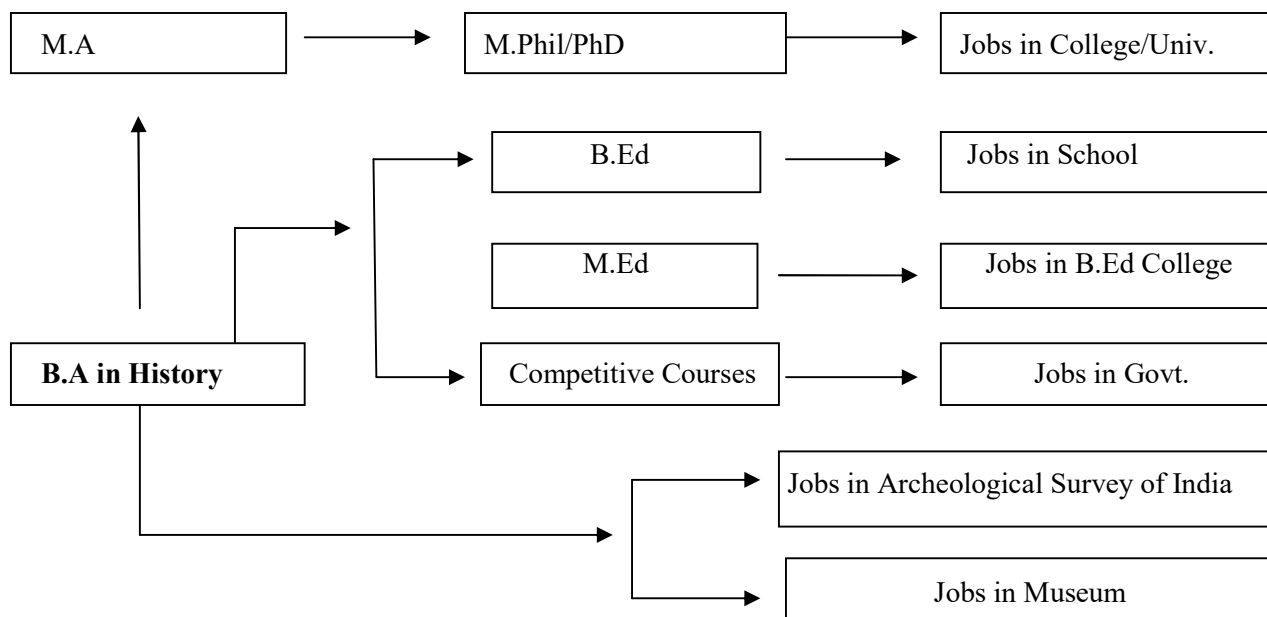

A student after completion of graduation with history subject or master with history has ample scope for career building. Here we tried to focus some general field like after completion of graduation with history he/she will be eligible for any govt./private job.(2) Tourism is very close field for history. So he/she after completion of Tourism certificate/diploma Course will be eligible for job in tourism department/PSU and can engage himself/herself as tourist guide. (3) He/she may pursue B.Ed course and get employment as teacher in Govt./Private school or may get employment as Education office like school inspection, etc. (4) After completion of M.Ed, there is a scope of employment in B.Ed college as faculty of method subject. (5) History subject is preferred by many for competitive examination. There is a scope to be administrative officer on allied service under Union or state Public service. (6) There is also scope for pursuing education in sociology / social services for Govt./NGO service. (7) Many students of history background prefer LL.B.. After completion of LLB he/she may either prefer Judiciary service or may engage as private (law) practice. There is also scope for job as law officer in Govt/Private section. (8) Going one step ahead with LL.M. engagement as faculty member in law college is possible. (9) Employment opportunity is also high in Archaeological department and Museum with history background. (10) Besides the above mentioned scopes after MA degree one may get employment in Higher Secondary

school, Junior college and in Degree College as faculty. (11) After completion of M.Phil/Ph.D scope for employment as faculty member in college/University is high.

These are some very common scopes with history background. Besides these, there are countless opportunities for student in the days of globalization. The main thing is dedication and sincerity and keeping update oneself for grabbing opportunities.

Programme Outcome:

Department of Political Science

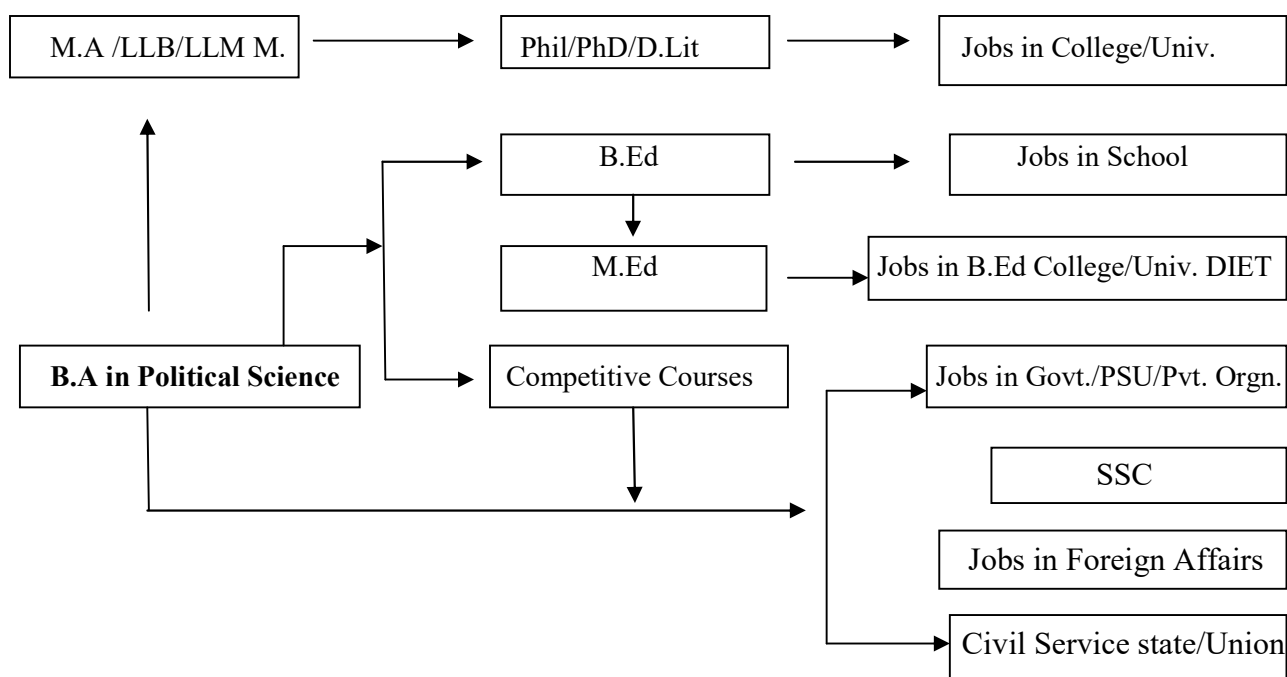

Students after completing of BA in Political Science can pursue PG in the subject & by completing M.Phil/PhD they can get jobs in College or University. Another scope is pursuing B.Ed to get jobs in school or after BEd by completing M.Ed. they can choose the profession of teaching in B.Ed. college/University DIET. After graduating in Political Science various options are open to them. They can either appear in the competitive exam or be employed in Govt/PSU/Pvt. Organizations, civil services or foreign affairs. There is also scope of appearing the examinations of state and Union, Selection commission, LLB & LLM courses. are also open to them. Students can pursue MA in library science to be qualified for the post of librarian in colleges/Universities/Govt. Libraries/ Institutions.

Programme Outcome:

**Department of Commerce
(Accountancy, Banking, Management & Commerce General)**

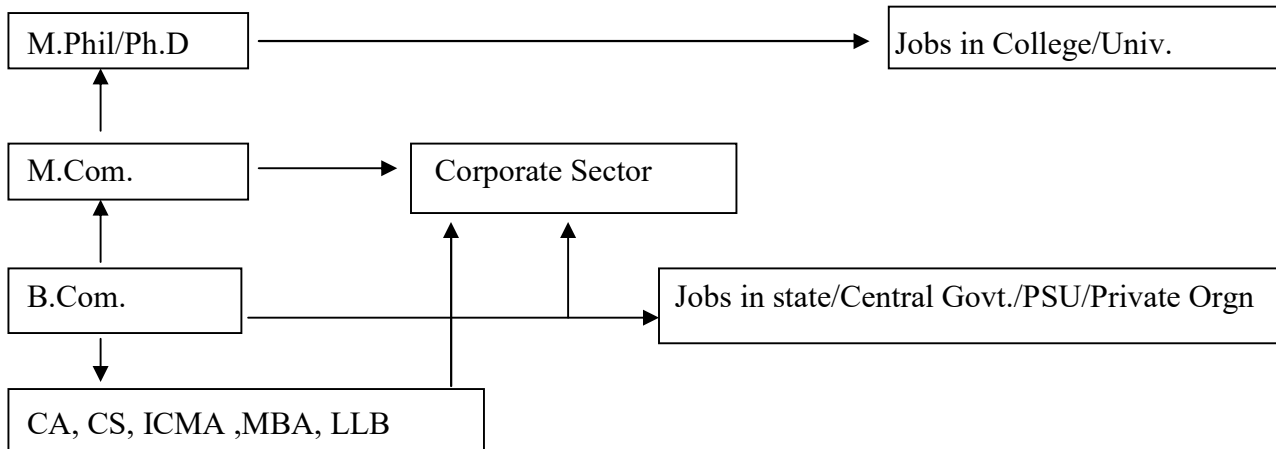

After graduating from the Department of Commerce, a student can enroll for various other degrees like M. Com, CA, CS, ICMA, MBA, LLB etc. After completing M.Com. they can get jobs in Corporate Sector. They can also pursue for M.Phil/Pd.D degrees as farther higher studies leading them to take up jobs in colleges and Universities.

A commerce degree student can also opt for jobs in various State Government, Central Government, PSU's or any other private organizations.

Programme Outcome:

Department of Botany

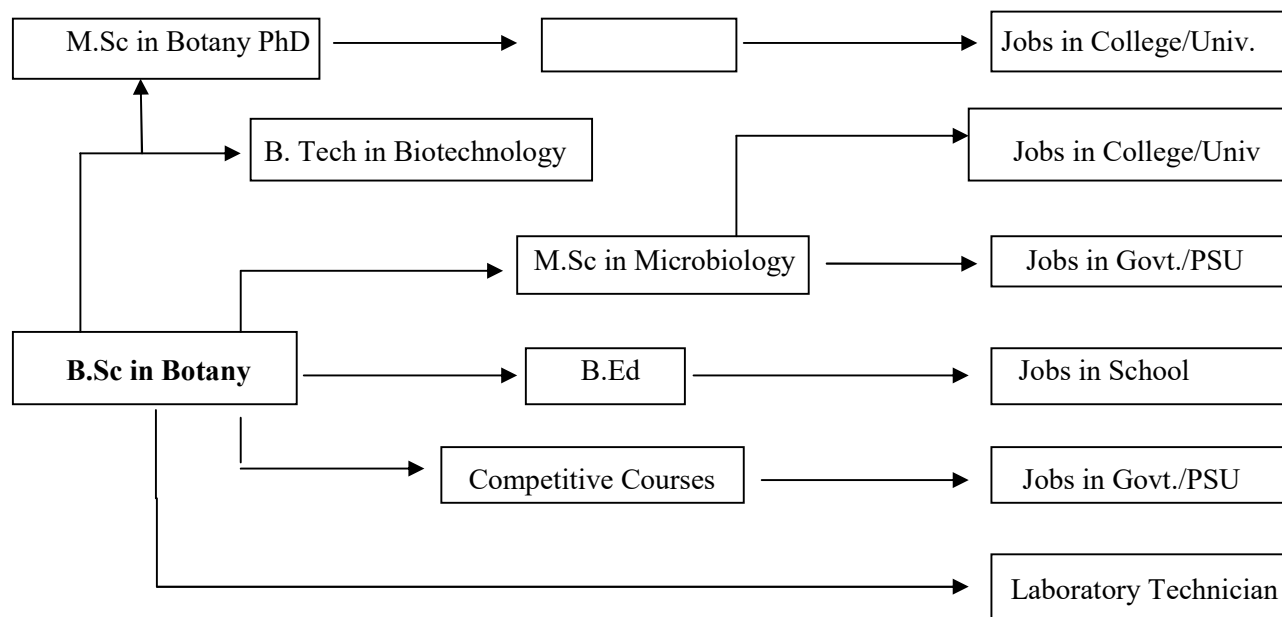

For students after completion of B.Sc in Botany can opt for pursuing M.Sc not only in Botany but also in various subjects like Vivology, Home Science , Bio-informatics, Eco-restoration, Ethno-botany, Molecular biology, Bio-conservation, Big data science, Biostatistics, Microbiology, Biochemistry etc. There after by pursuing Ph.D/M.Phil there is opportunity of jobs in college & University. After graduation they can chose jobs in any Govt. /PSU or work as laboratory technician. After B.Sc in Botany there is also scope for B.Tech in Bio-Technology, B.Ed & then to M.Ed where is the opportunity of jobs in schools & B.Ed colleges.

There is also scope for pursuing Diploma course in Radio therapy, Physio Therapy, ECG technology, Nursing, Horticulture, Floriculture, Sericulture, Apiculture etc. or they can appear in the competitive examination after which various doors of jobs are open to them.

Programme Outcome: Department of Chemistry

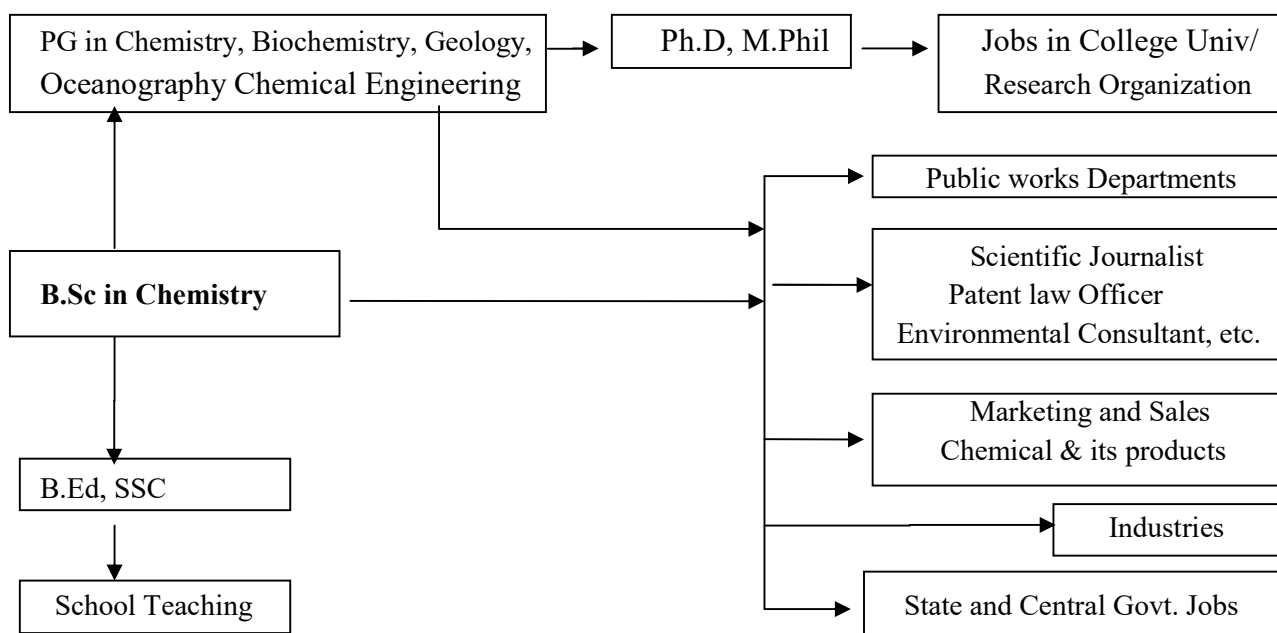

A degree in chemistry opens the door to a variety of careers in chemistry, Biology, physics and other natural sciences. Many students who have completed B.Sc (Hons) chemistry can prepare for a career as a chemical engineer, chemist or even as an engineer in other field.

Government jobs like Banking, SSC, Railways etc. Thus subject like chemistry can offer a wide range of employment opportunities to candidates in both private as well as government sectors. B.SC Chemistry candidates can also pursue their career in the field of teaching and technical writer.

After doing B.SC Chemistry one can go for M.SC in Chemistry, Biochemistry, Geology, Oceanography, Chemical engineering etc. There after Ph.D, M.Phil and jobs in Colleges, Universities, Research organizations etc.

After doing B.SC Chemistry one can go for various jobs and also take up internship to prepare for industry level entries. Some of the jobs are mentioned bellow:

- Analytical chemist
- Bio Medical chemist
- Lab chemist
- Production chemist
- Production Officer
- Material technologist
- Quality controller
- Chemical Engineering Associate
- Industrial Research Scientist
- Safety health and environment specialist.

Programme Outcome:

Department of Mathematics

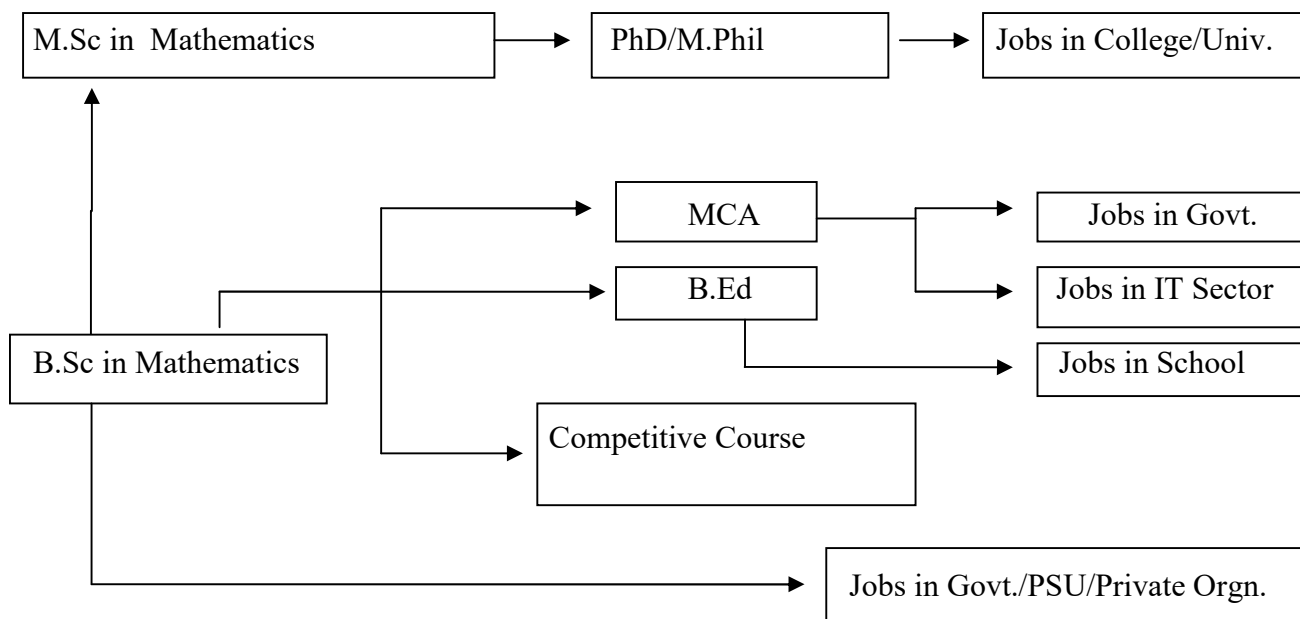

This diagram is regarding the layout of a complete roadmap that a student might opt after completing their graduation for a career ahead. For students after completion of B.Sc. in Mathematics can opt for doing M.Sc. in Mathematics which would lead them to further opting for Ph.D./M.Phil. and then obtaining jobs in College/University. Another option for students after B.Sc. in Mathematics is to prepare and get jobs in govt./PSU/Private Organization. Another route that can be taken would be to do B.Ed. after B.Sc. in Mathematics and then opt for doing jobs in school. MCA would also be another good option after completion of B.Sc. in Mathematics which leads to jobs in either Govt. or IT sector. Preparing for competitive course after B.Sc. Mathematics is also another option. That would be the choices after doing B.Sc. in Mathematics so the students need to be smart in their approach.

Programme Outcome:

Department of Physics

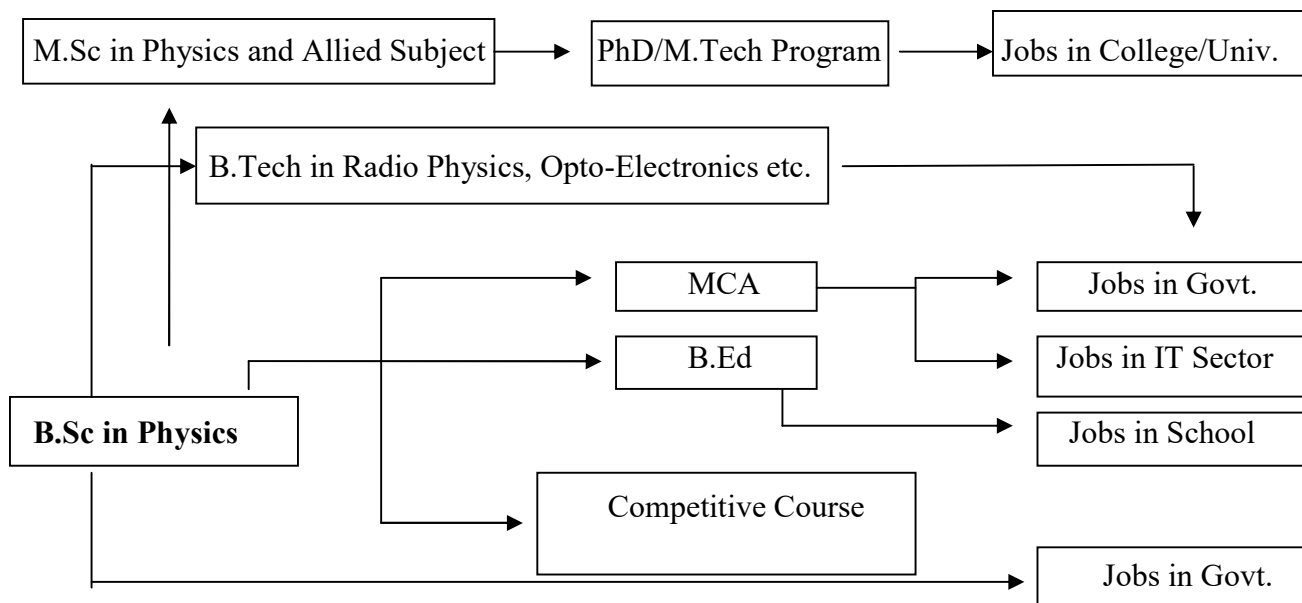

After passing out B.Sc. in Physics, a student can get directly admitted in M.Sc. Physics & Electronics & M.Tech. Course. After doing Ph.D. the student can have in colleges or Universities. After graduation B.Sc. Physics the students can also study B.Tech. in Radio Physics, Opto-electronics which may give choice in Jobs in Govt. in IT sector or even in schools as Science teacher. Other options after B.Sc. Physics are the MCA, B.Ed. course which provides the opportunity of Jobs in Government and Private Sector, IT sector or in school. They can pursue competitive courses to enhance their efficiency for different types of services.

Programme Outcome:

Department of Statistics

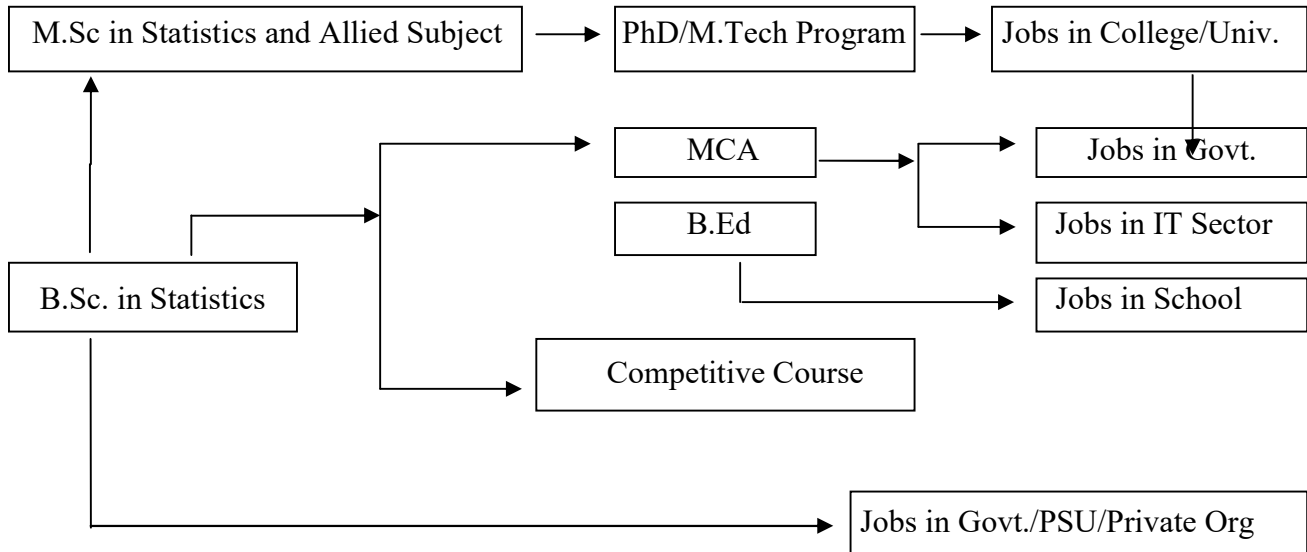

This diagram is regarding the layout of a complete roadmap that a student might opt after completing their graduation for a career ahead. Students after completion of B.Sc. in Statistics can opt for doing M.Sc. in Statistics, which would lead them to further opting for Ph.D./M.Phil., and then obtaining jobs in Colleges/University. Another option for students after graduation in Statistics is to prepare and get jobs in govt./PSU/Private Organization. Another route that can be taken would be to do B.Ed. after B.Sc. in Statistics and then opt for doing jobs in school. MCA would also be another good option after completion of B.Sc. in Statistics which leads to jobs in either Govt. or IT sector. Department of Economics and statistics generally recruit employees having B.Sc. /M.Sc. in Statistics in their Department.

Programme Outcome:

Department of Zoology

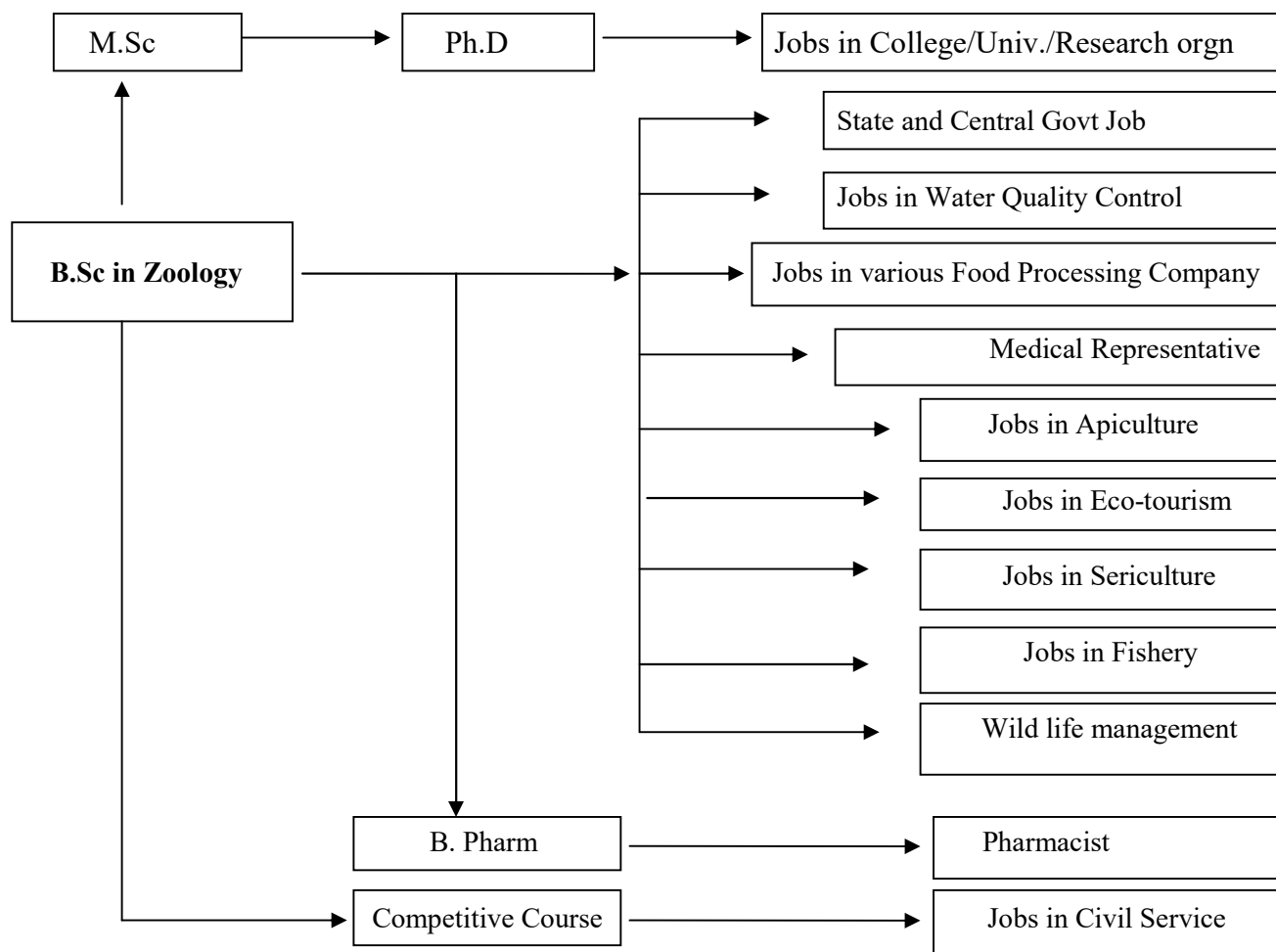

After completion of B.Sc. student may go for higher study or for some competitive courses for civil services of Govt. or other services. After specialization (Higher study) they may enter in teaching jobs in college/Universities/Research organization.

After doing B.Sc. in Zoology one will be eligible for jobs in various food Processing Company, Fishery, Apiculture, Sericulture, Eco-tourism, Water quality control, Wild life Management.

There is also an option for Medical Representative apart from all there they can avail scopes in pharmaceutical industries/companies with specialization.

Programme Outcome:

Department of Computer Science

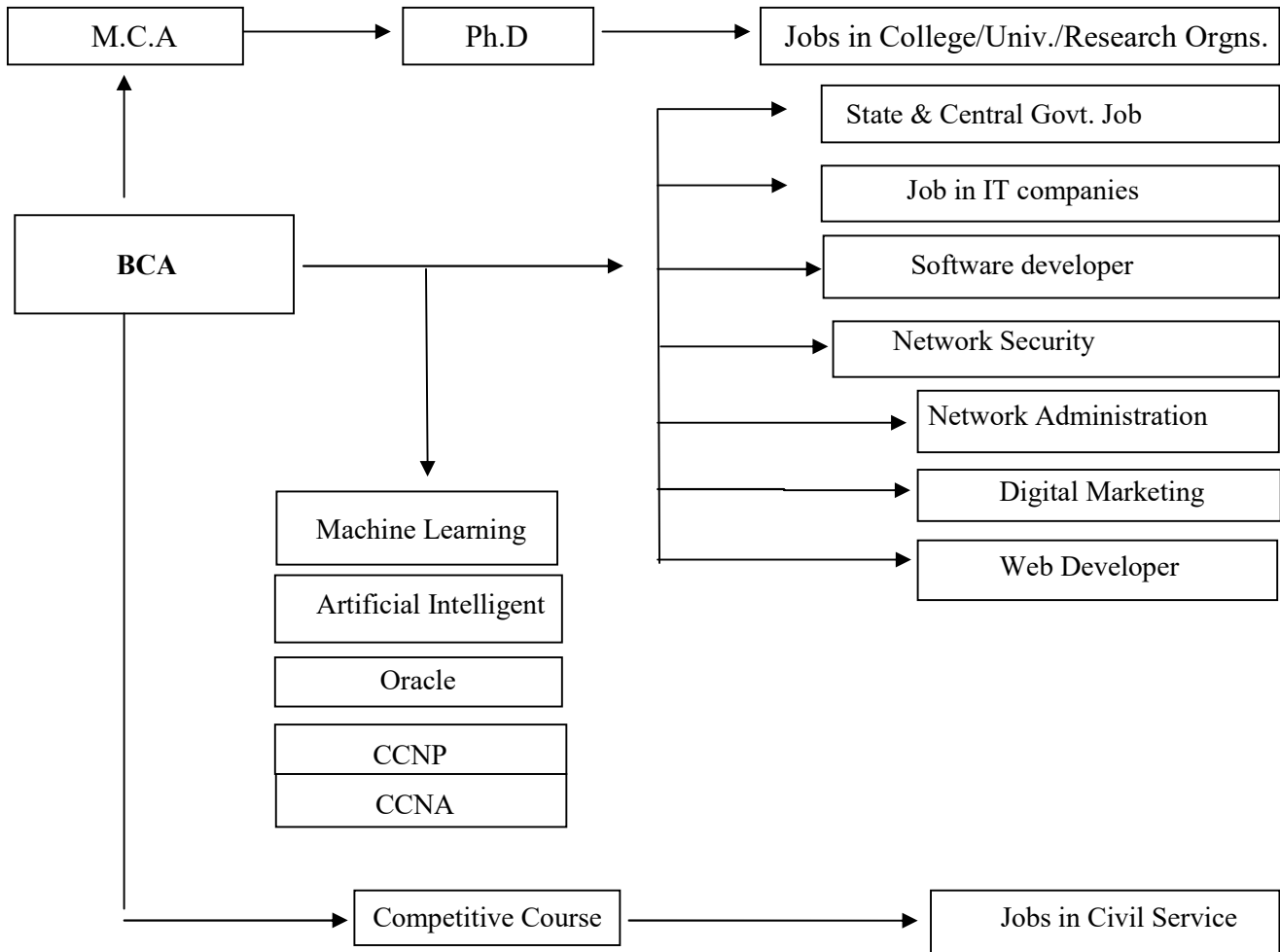

After Completion of BCA student may go for higher Study in Universities. After specialization they may enter in teaching jobs in College/Universities/Research organization. There is also scope for some competitive courses to be eligible for jobs in Civil Services.

After doing BCA, other options for study various courses are Artificial intelligence, Machine learning, Oracle, CCNP, CCNA etc. They can also go for types of jobs like IT companies, Software Developer, Software Testing, Network Security, Network administration, Digital Marketing, Web developer etc.